

UC CACC FP CA 02

10G BS Angle Faceplate with Shutter, 2-port , White

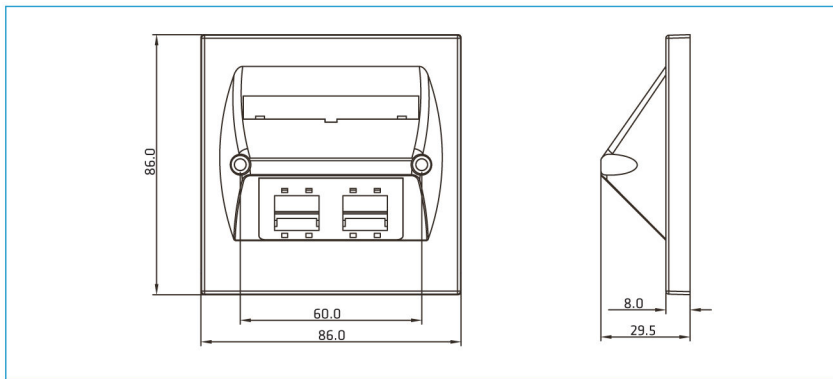

Ordering Information

SAP IC	UC P/N	UC Material Code	Product Description	P.U
YFPBP00352	FPCA9287	UC CACC FP CA 02	10G BS Angle Faceplate with Shutter, 2-port , White	1pc/bag